

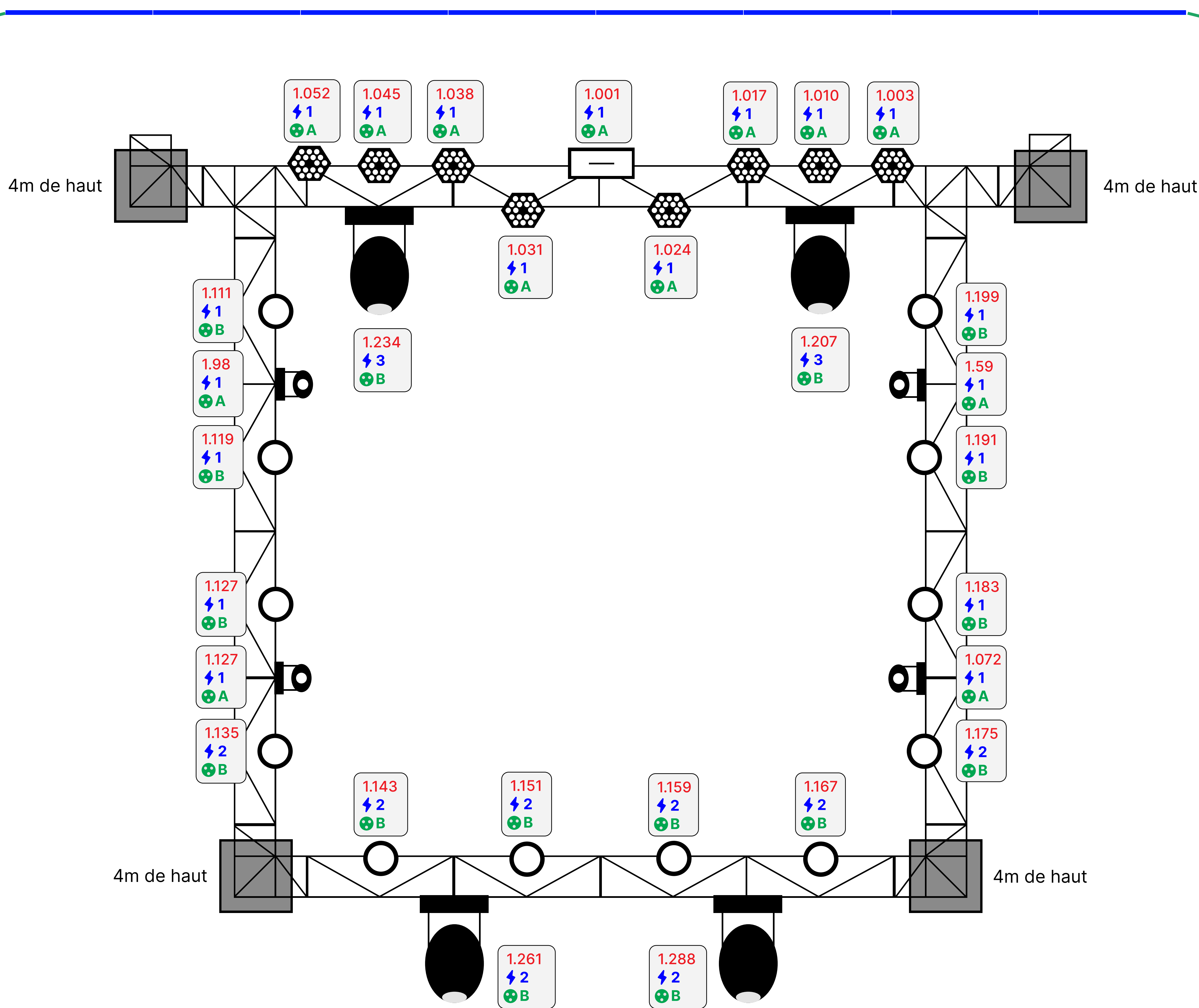

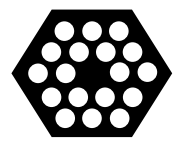

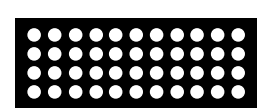
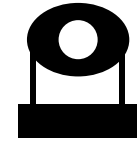

Top view

Front scene

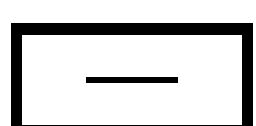
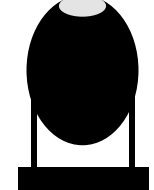
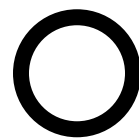

Légende







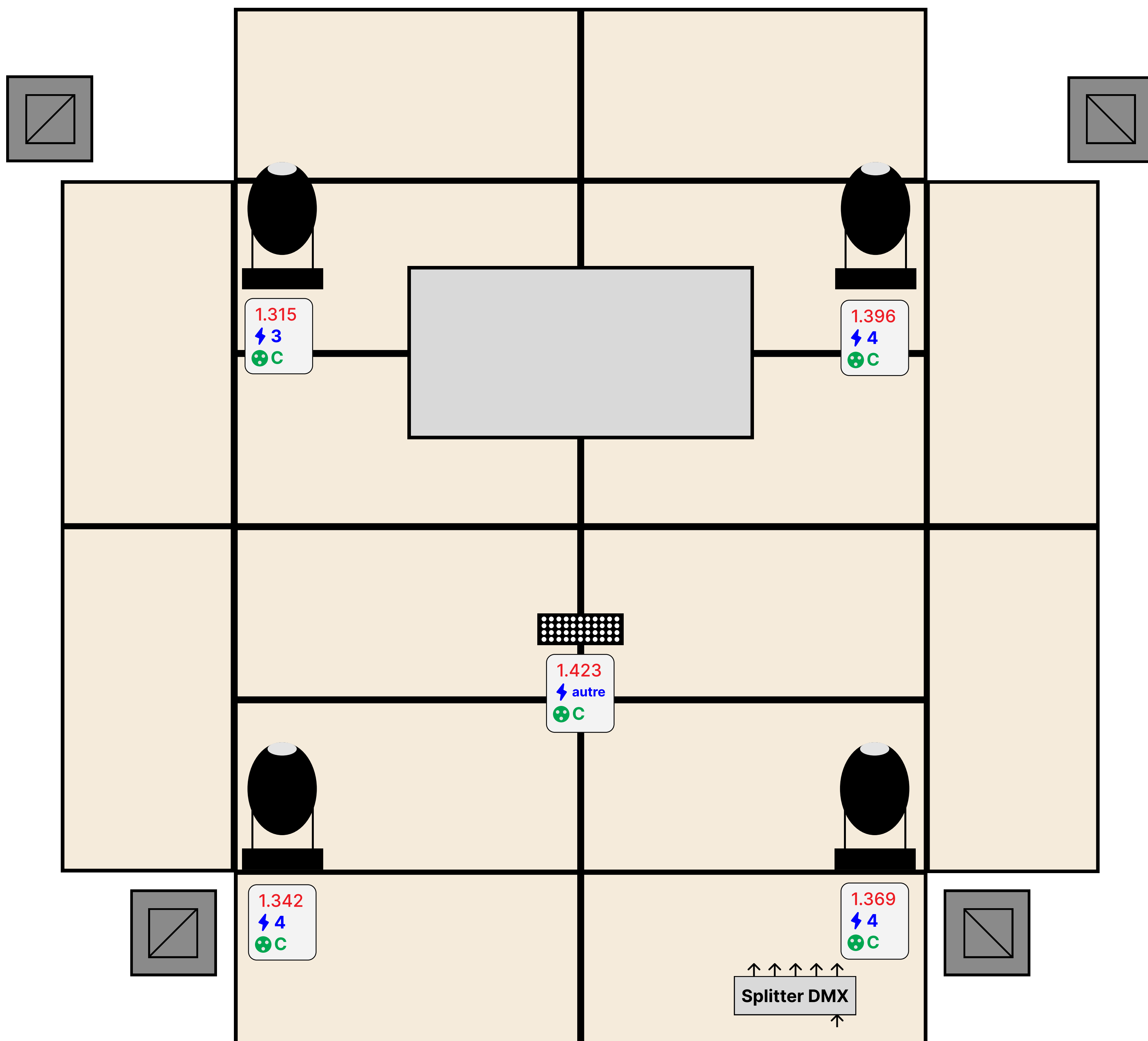

- | | | | |
|------------------------------------------------------------------------------------------------------------------------------------------------------|--------------------------------------------------------------------------------------------------------------------------------------------|----------------------------------------------------------------------------------------------------------------------------------------------|----------------------------------------------------------------------------------------------------|
|  [Stairville] Tri Flat PAR Profile 18x3W
Mode : 7ch
3 poles |  [SGM] P-5
Mode : 9ch
5 poles |  [Showtec] Phantom 50
Mode : 13ch
3 poles |  Vauban |
|  [Stairville] Stroboscope 1500W
Mode : 2ch
3 & 5 poles |  [MARTIN] Mac Quantum Profile
Mode : 27ch
5 poles |  [Cameo] Zenit P130 LSD
Mode : 8ch mode 2
5 poles |  Crash |
| | | |  DMX 5 poles |
| | | |  DMX 3 poles |
| | | |  Rallonge T13 |

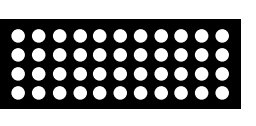
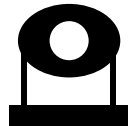
Plateau view

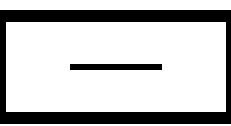
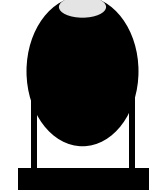
Front scene







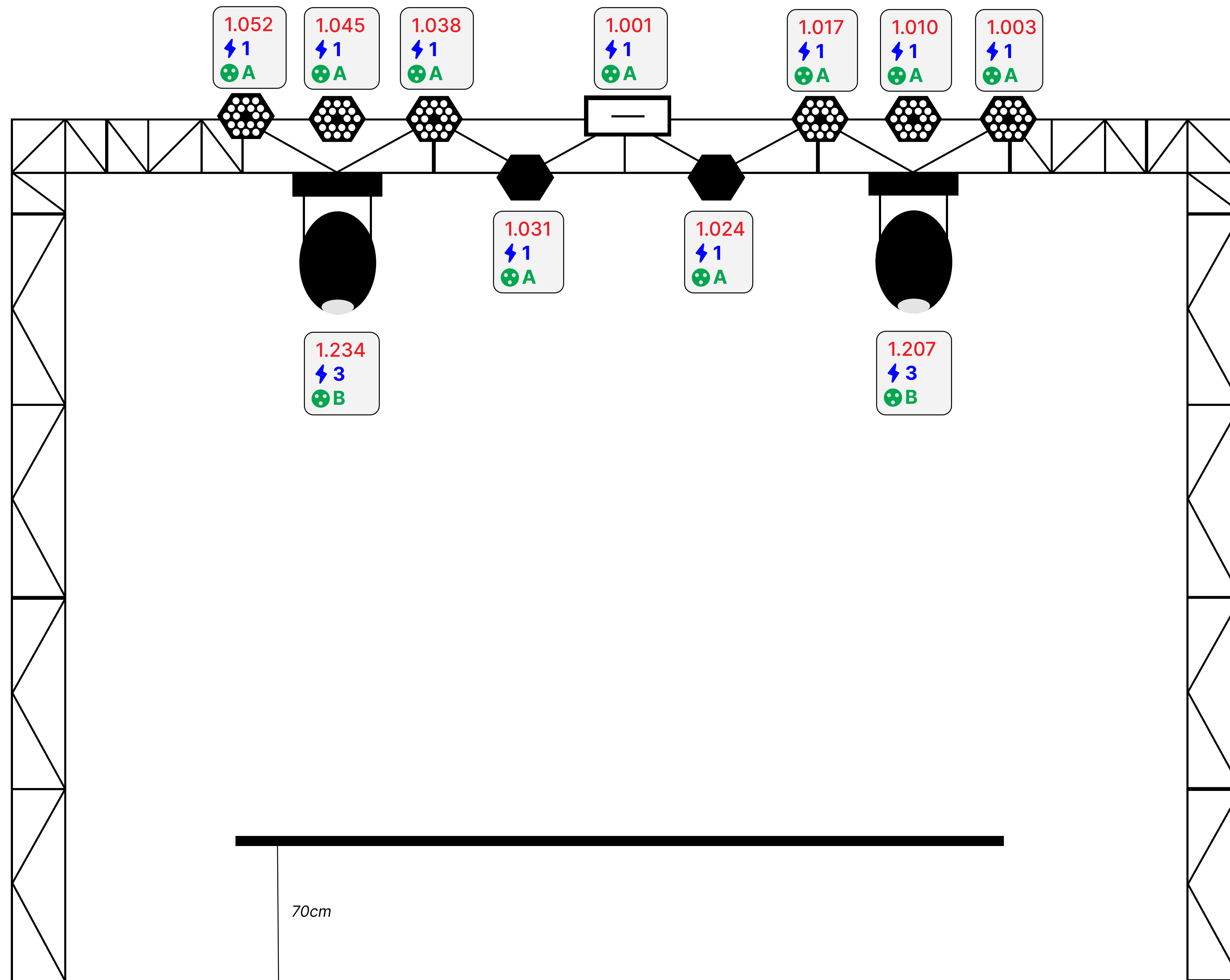

Légende

- | | | | | | | | |
|-------------------------------------------------------------------------------------|------------------------------------------------------------------|-------------------------------------------------------------------------------------|--------------------------------------------------------|---------------------------------------------------------------------------------------|--------------------------------------------------------|---------------------------------------------------------------------------------------|--------------|
|  | [Stairville] Tri Flat PAR Profile 18x3W
Mode : 7ch
3 poles |  | [SGM] P-5
Mode : 9ch
5 poles |  | [Showtec] Phantom 50
Mode : 13ch
3 poles |  | Vauban |
|  | [Stairville] Stroboscope 1500W
Mode : 2ch
3 & 5 poles |  | [MARTIN] Mac Quantum Profile
Mode : 27ch
5 poles |  | [Cameo] Zenit P130 LSD
Mode : 8ch mode 2
5 poles |  | Crash |
| | | | | | |  | DMX 5 poles |
| | | | | | |  | DMX 3 poles |
| | | | | | |  | Rallonge T13 |

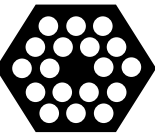
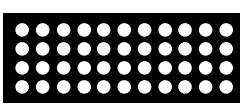
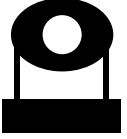
Front view

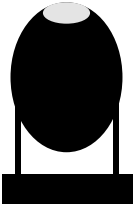
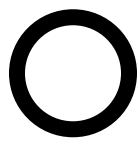

Légende







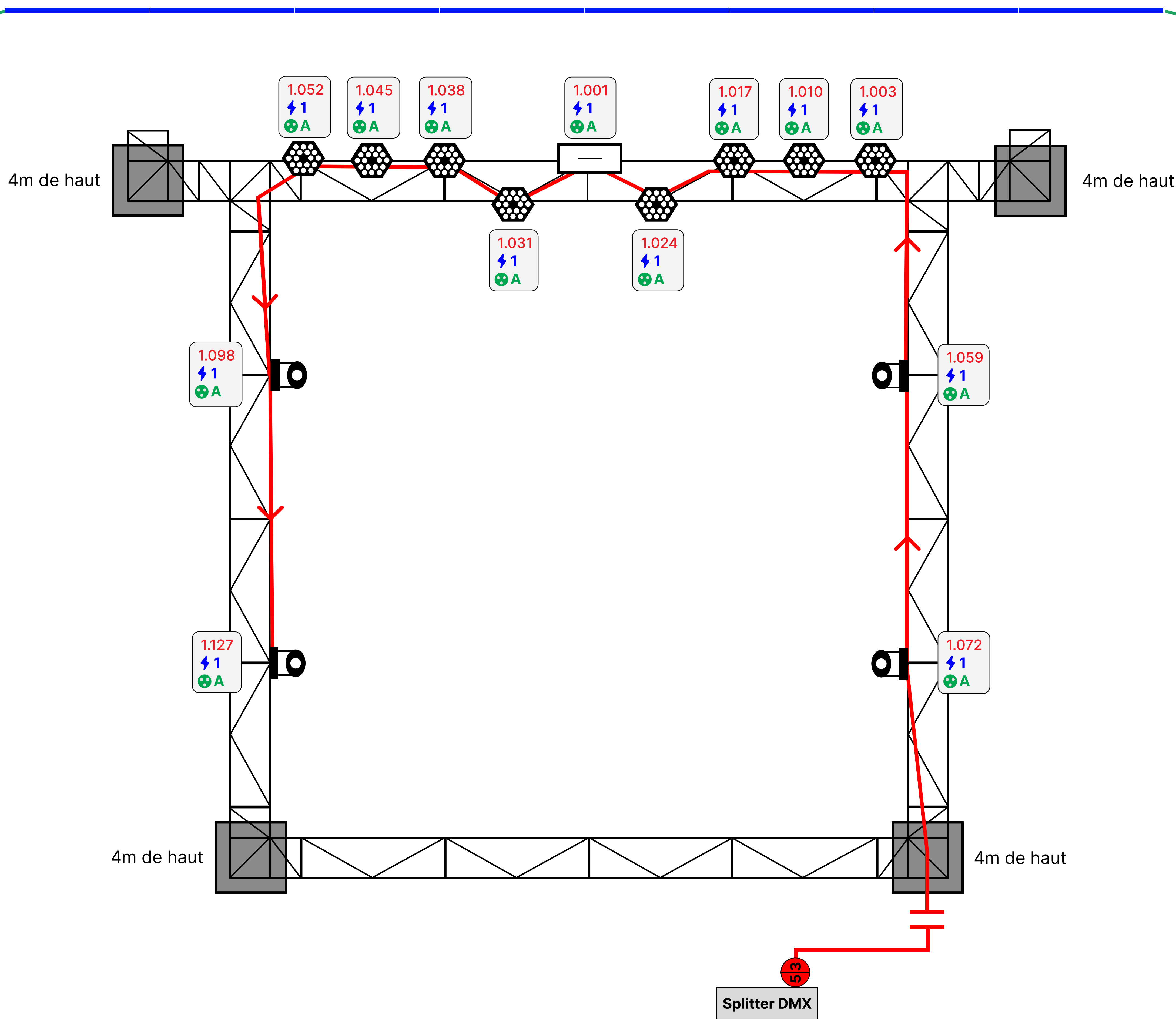

- | | | | | | | | |
|-------------------------------------------------------------------------------------|------------------------------------------------------------------|-------------------------------------------------------------------------------------|--------------------------------------------------------|---------------------------------------------------------------------------------------|--------------------------------------------------------|---------------------------------------------------------------------------------------|--------------|
|  | [Stairville] Tri Flat PAR Profile 18×3W
Mode : 7ch
3 poles |  | [SGM] P-5
Mode : 9ch
5 poles |  | [Showtec] Phantom 50
Mode : 13ch
3 poles |  | Vauban |
|  | [Stairville] Stroboscope 1500W
Mode : 2ch
3 & 5 poles |  | [MARTIN] Mac Quantum Profile
Mode : 27ch
5 poles |  | [Cameo] Zenit P130 LSD
Mode : 8ch mode 2
5 poles |  | Crash |
| | | | | | |  | DMX 5 poles |
| | | | | | |  | DMX 3 poles |
| | | | | | |  | Rallonge T13 |

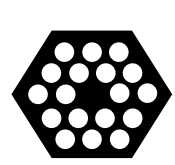
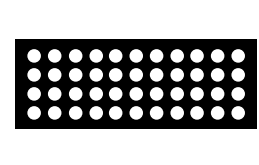
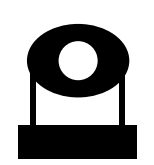
Top view - DMX A

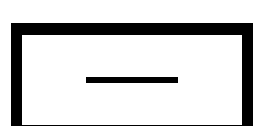
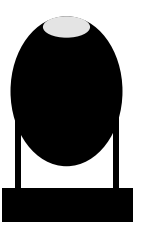
Front scene



Légende





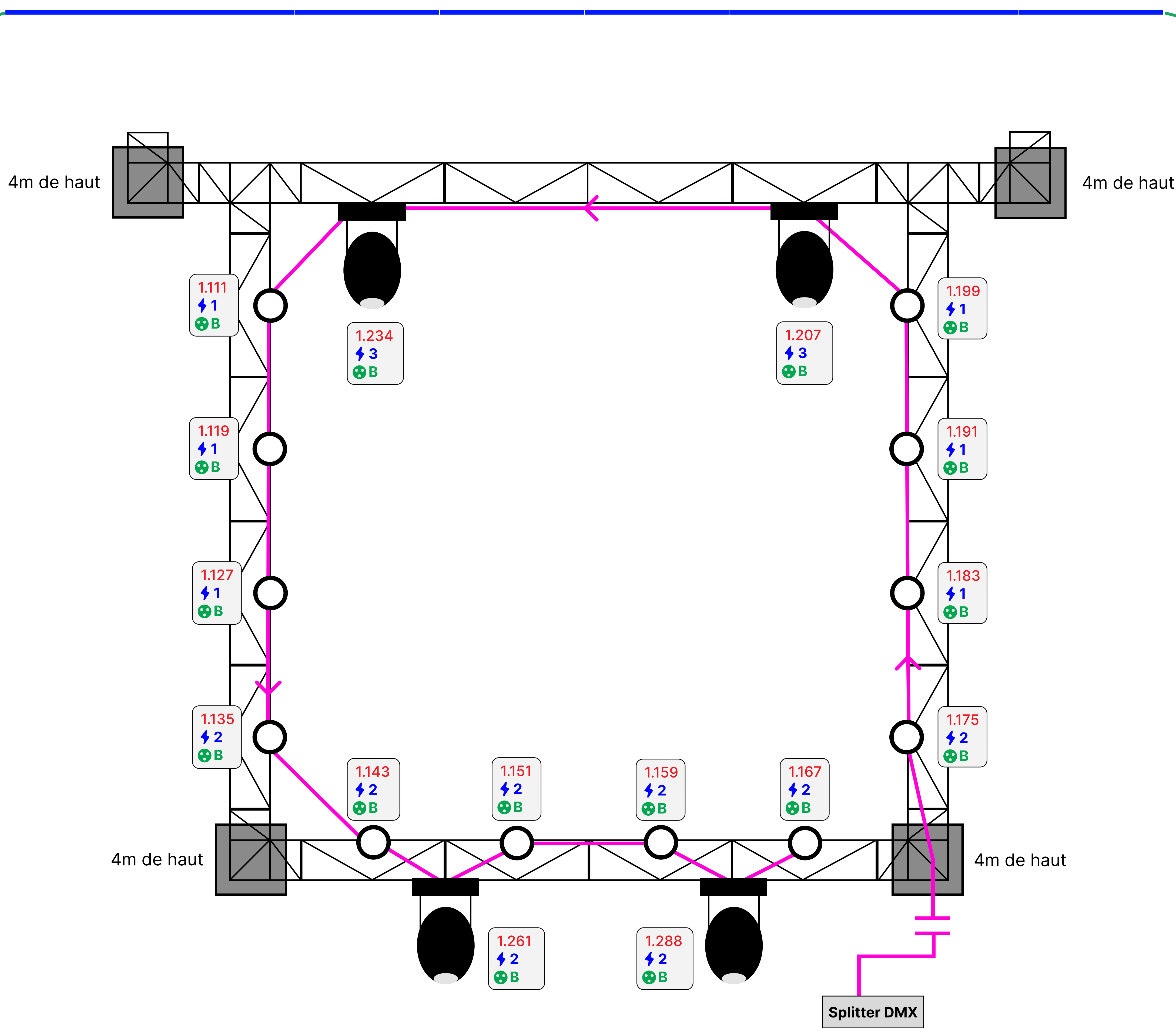

- | | | | |
|------------------------------------------------------------------------------------------------------------------------------------------------------|--------------------------------------------------------------------------------------------------------------------------------------------|----------------------------------------------------------------------------------------------------------------------------------------------|----------------------------------------------------------------------------------------------------|
|  [Stairville] Tri Flat PAR Profile 18x3W
Mode : 7ch
3 poles |  [SGM] P-5
Mode : 9ch
5 poles |  [Showtec] Phantom 50
Mode : 13ch
3 poles |  Vauban |
|  [Stairville] Stroboscope 1500W
Mode : 2ch
3 & 5 poles |  [MARTIN] Mac Quantum Profile
Mode : 27ch
5 poles |  [Cameo] Zenit P130 LSD
Mode : 8ch mode 2
5 poles |  Crash |
| | | |  DMX 5 poles |
| | | |  DMX 3 poles |
| | | |  Rallonge T13 |

Top view - DMX B

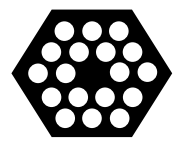
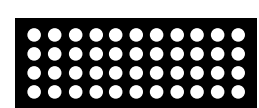
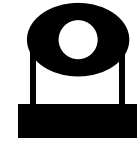
Front scene

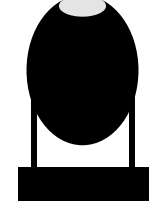
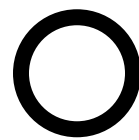

Légende





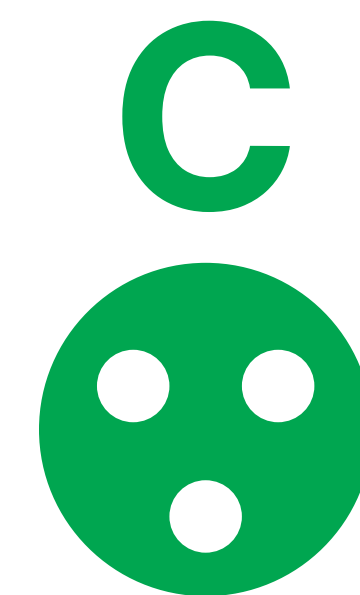
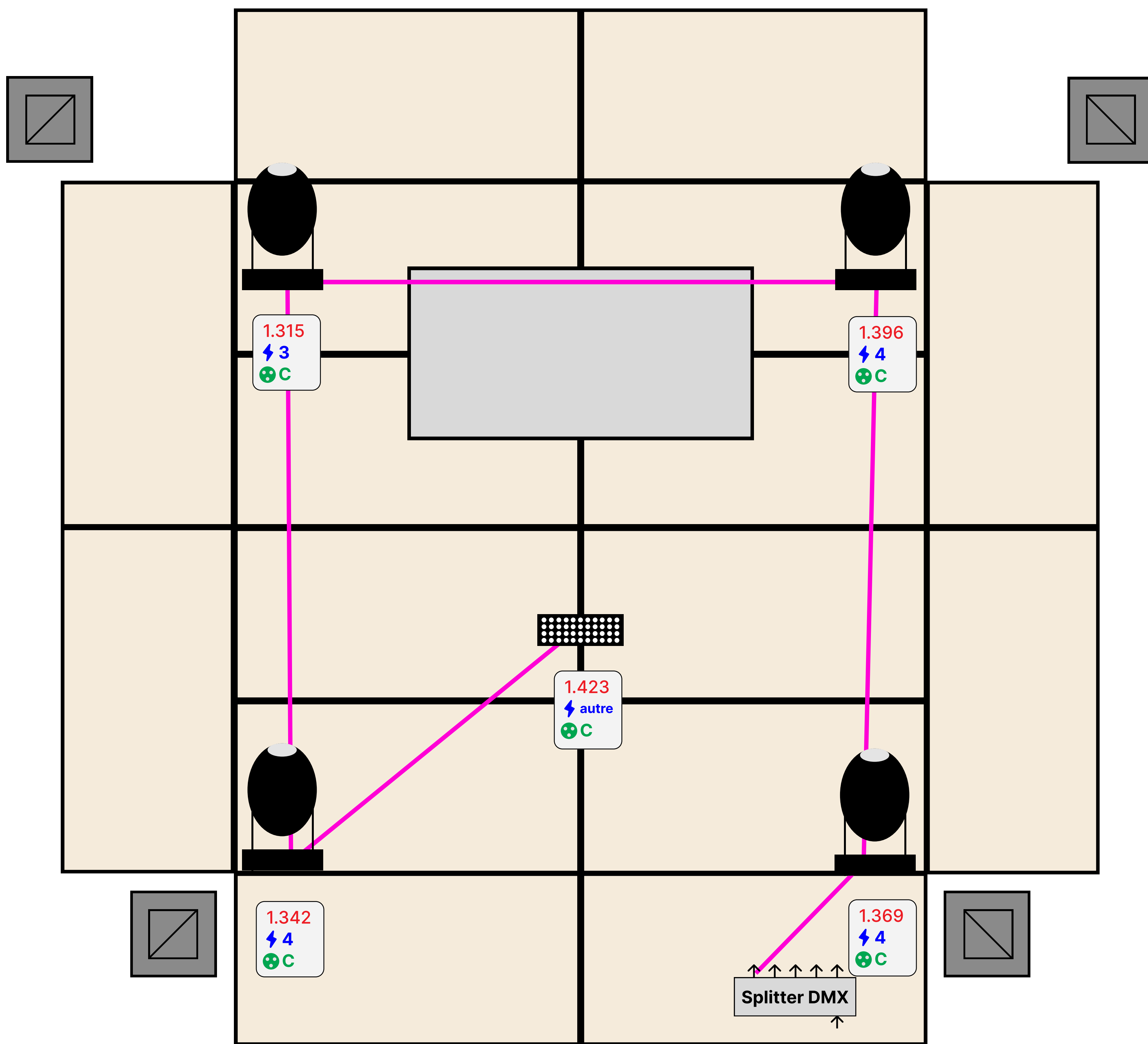

- | | | | | | | | |
|-------------------------------------------------------------------------------------|------------------------------------------------------------------|-------------------------------------------------------------------------------------|--------------------------------------------------------|---------------------------------------------------------------------------------------|--------------------------------------------------------|---------------------------------------------------------------------------------------|--------------|
|  | [Stairville] Tri Flat PAR Profile 18×3W
Mode : 7ch
3 poles |  | [SGM] P-5
Mode : 9ch
5 poles |  | [Showtec] Phantom 50
Mode : 13ch
3 poles |  | Vauban |
|  | [Stairville] Stroboscope 1500W
Mode : 2ch
3 & 5 poles |  | [MARTIN] Mac Quantum Profile
Mode : 27ch
5 poles |  | [Cameo] Zenit P130 LSD
Mode : 8ch mode 2
5 poles |  | Crash |
| | | | | | |  | DMX 5 poles |
| | | | | | |  | DMX 3 poles |
| | | | | | |  | Rallonge T13 |

Plateau view - DMX C

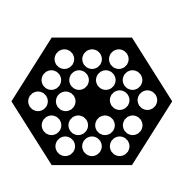
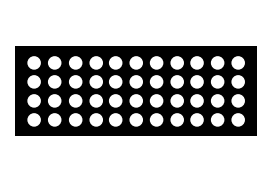
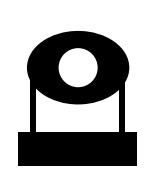
Front scene

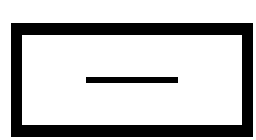
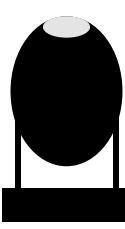
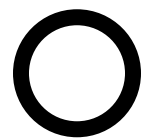

Légende







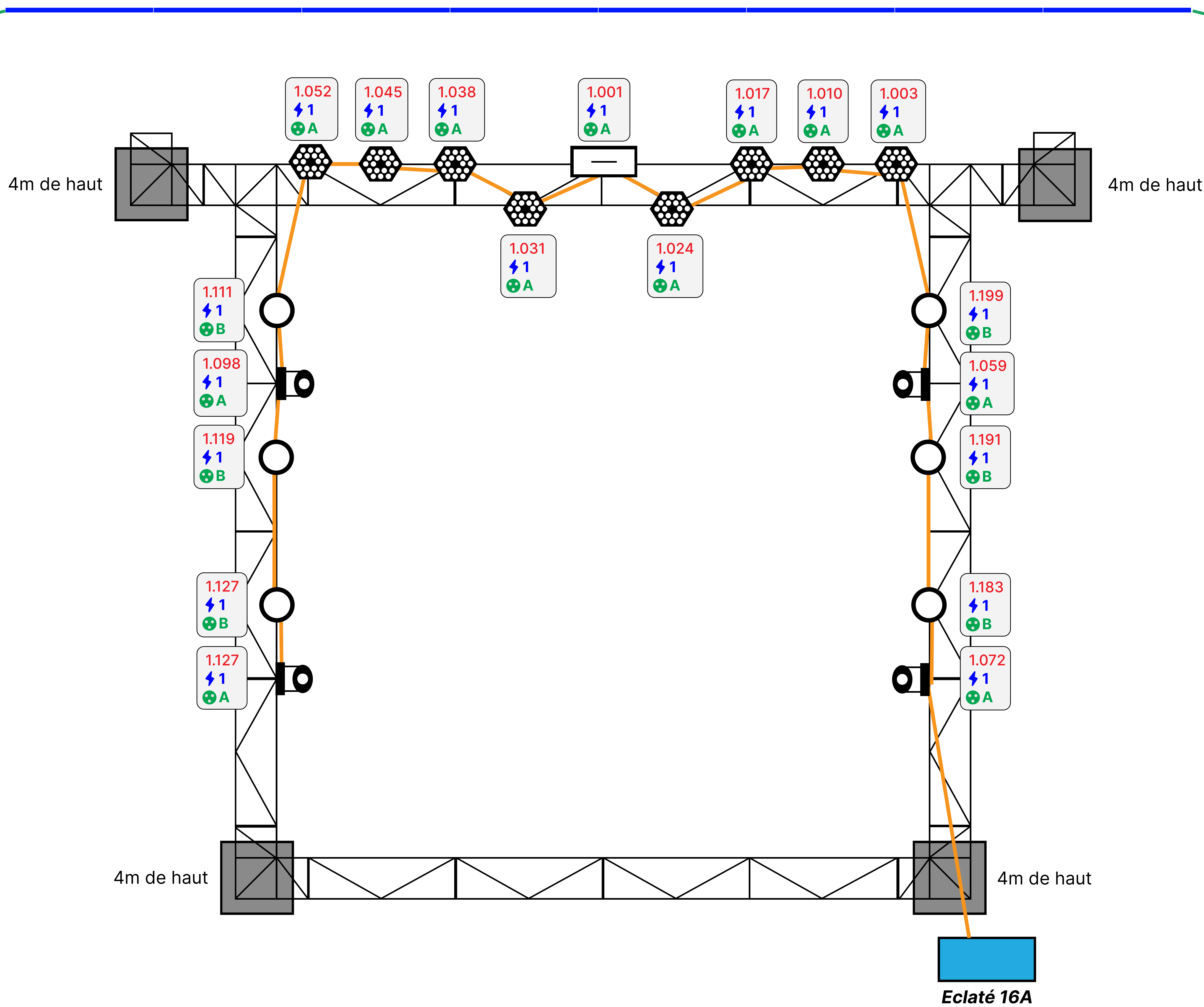

- | | | | | | | | |
|-------------------------------------------------------------------------------------|------------------------------------------------------------------|-------------------------------------------------------------------------------------|--------------------------------------------------------|---------------------------------------------------------------------------------------|--------------------------------------------------------|---------------------------------------------------------------------------------------|--------------|
|  | [Stairville] Tri Flat PAR Profile 18x3W
Mode : 7ch
3 poles |  | [SGM] P-5
Mode : 9ch
5 poles |  | [Showtec] Phantom 50
Mode : 13ch
3 poles |  | Vauban |
|  | [Stairville] Stroboscope 1500W
Mode : 2ch
3 & 5 poles |  | [MARTIN] Mac Quantum Profile
Mode : 27ch
5 poles |  | [Cameo] Zenit P130 LSD
Mode : 8ch mode 2
5 poles |  | Crash |
| | | | | | |  | DMX 5 poles |
| | | | | | |  | DMX 3 poles |
| | | | | | |  | Rallonge T13 |

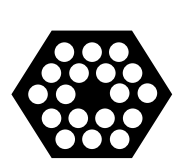
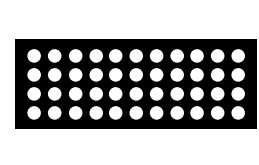
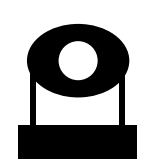
Top view - ELEC 1

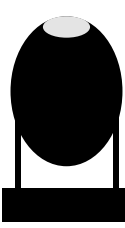
Front scene



Légende







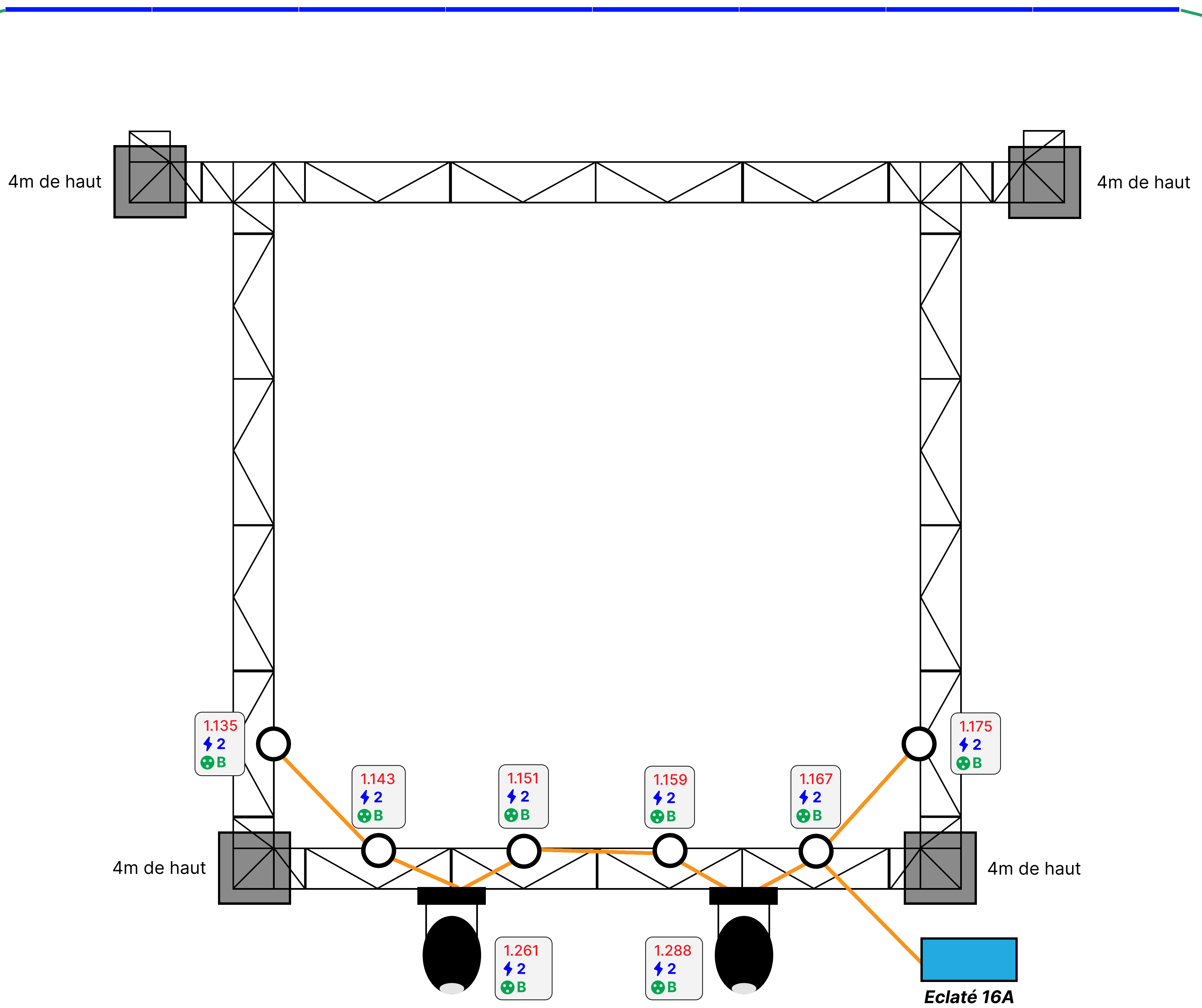

- | | | | |
|------------------------------------------------------------------------------------------------------------------------------------------------------|--------------------------------------------------------------------------------------------------------------------------------------------|----------------------------------------------------------------------------------------------------------------------------------------------|----------------------------------------------------------------------------------------------------|
|  [Stairville] Tri Flat PAR Profile 18x3W
Mode : 7ch
3 poles |  [SGM] P-5
Mode : 9ch
5 poles |  [Showtec] Phantom 50
Mode : 13ch
3 poles |  Vauban |
|  [Stairville] Stroboscope 1500W
Mode : 2ch
3 & 5 poles |  [MARTIN] Mac Quantum Profile
Mode : 27ch
5 poles |  [Cameo] Zenit P130 LSD
Mode : 8ch mode 2
5 poles |  Crash |
| | | |  DMX 5 poles |
| | | |  DMX 3 poles |
| | | |  Rallonge T13 |

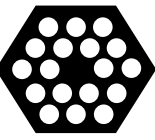
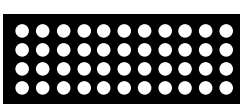
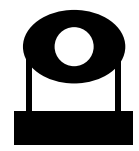
Top view - ELEC 2

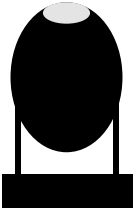
Front scene



Légende





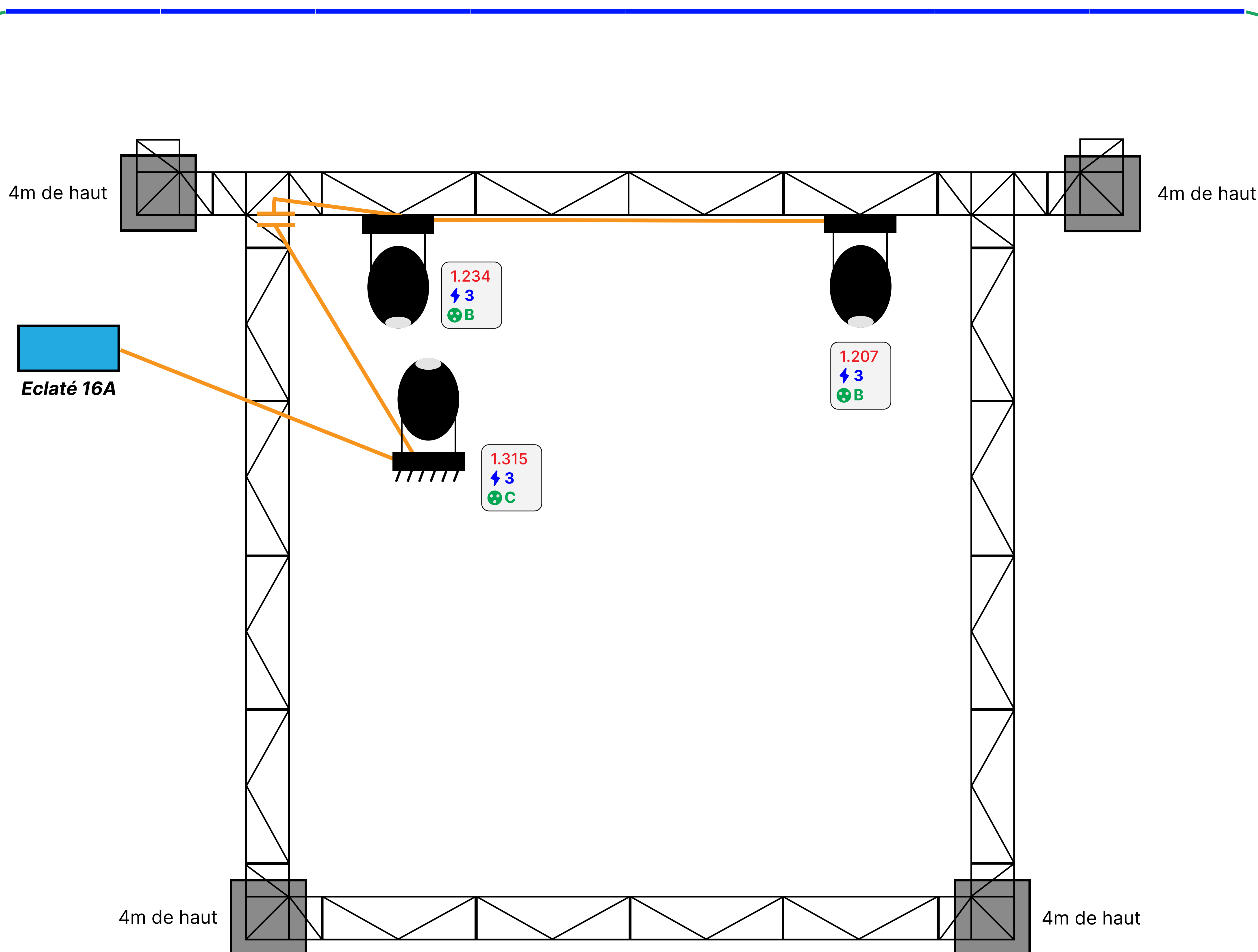

	[Stairville] Tri Flat PAR Profile 18×3W Mode : 7ch 3 poles		[SGM] P-5 Mode : 9ch 5 poles		[Showtec] Phantom 50 Mode : 13ch 3 poles		Vauban
	[Stairville] Stroboscope 1500W Mode : 2ch 3 & 5 poles		[MARTIN] Mac Quantum Profile Mode : 27ch 5 poles		[Cameo] Zenit P130 LSD Mode : 8ch mode 2 5 poles		Crash
							DMX 5 poles
							DMX 3 poles
							Rallonge T13

Top view - ELEC 3

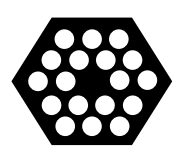
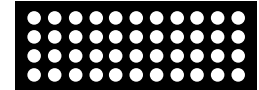
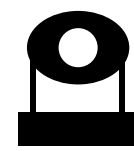
Front scene

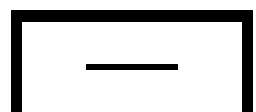
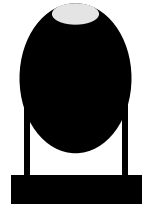
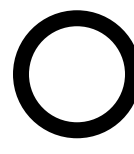

Légende

	[Stairville] Tri Flat PAR Profile 18×3W Mode : 7ch 3 poles		[SGM] P-5 Mode : 9ch 5 poles		[Showtec] Phantom 50 Mode : 13ch 3 poles		Vauban
	[Stairville] Stroboscope 1500W Mode : 2ch 3 & 5 poles		[MARTIN] Mac Quantum Profile Mode : 27ch 5 poles		[Cameo] Zenit P130 LSD Mode : 8ch mode 2 5 poles		Crash
							DMX 5 poles
							DMX 3 poles
							Rallonge T13





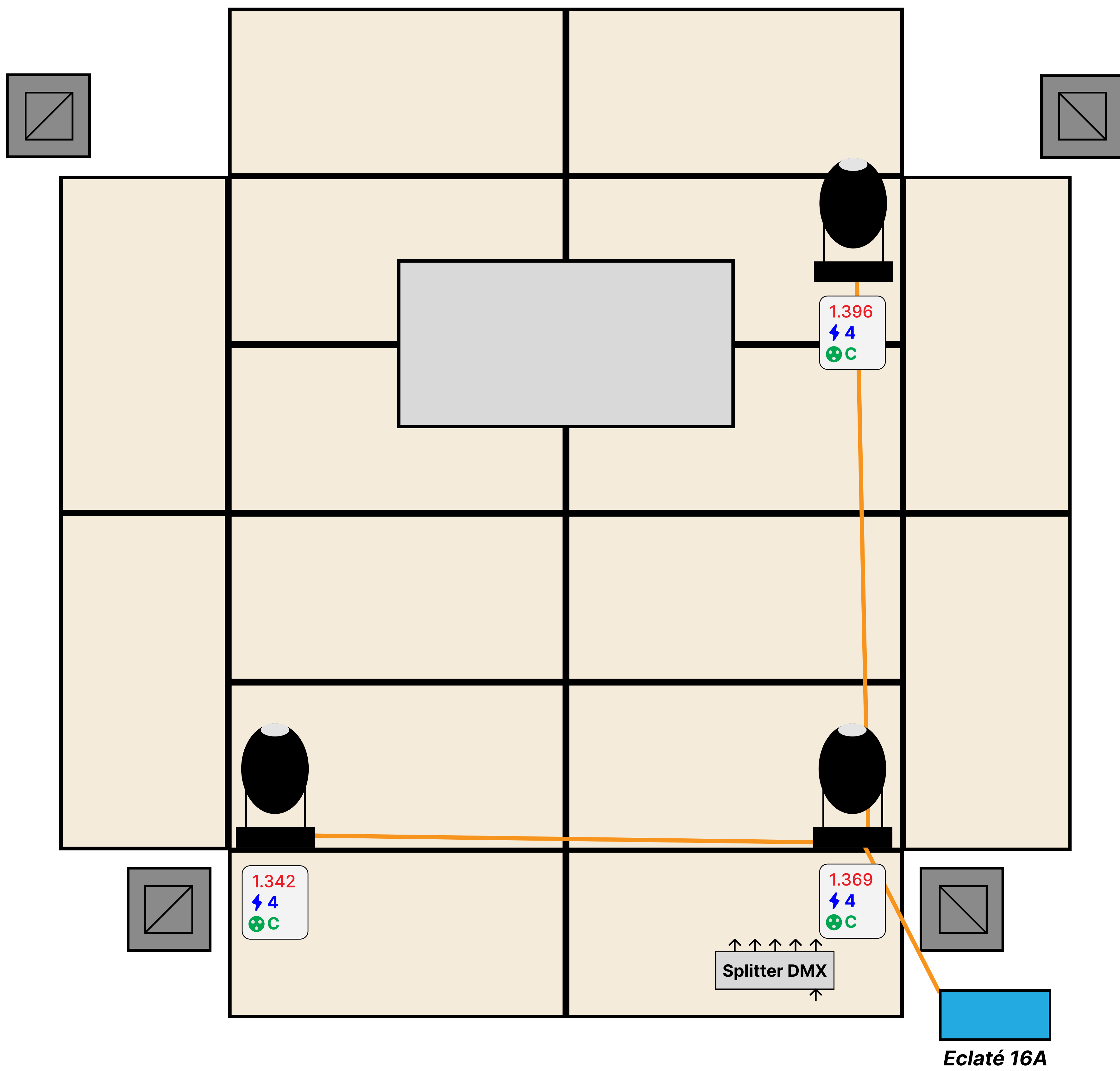

Plateau view - ELEC 4

Front scene

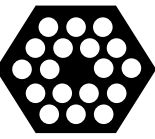
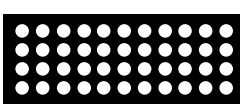
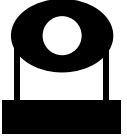

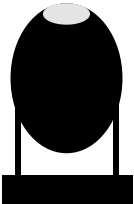
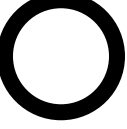
4

Légende

- | | | | | | | | |
|-------------------------------------------------------------------------------------|------------------------------------------------------------------|-------------------------------------------------------------------------------------|--------------------------------------------------------|---------------------------------------------------------------------------------------|--------------------------------------------------------|---------------------------------------------------------------------------------------|--------------|
|  | [Stairville] Tri Flat PAR Profile 18×3W
Mode : 7ch
3 poles |  | [SGM] P-5
Mode : 9ch
5 poles |  | [Showtec] Phantom 50
Mode : 13ch
3 poles |  | Vauban |
|  | [Stairville] Stroboscope 1500W
Mode : 2ch
3 & 5 poles |  | [MARTIN] Mac Quantum Profile
Mode : 27ch
5 poles |  | [Cameo] Zenit P130 LSD
Mode : 8ch mode 2
5 poles |  | Crash |
| | | | | | |  | DMX 5 poles |
| | | | | | |  | DMX 3 poles |
| | | | | | |  | Rallonge T13 |